

Jamming User Interfaces: Programmable Particle Stiffness and Sensing for Malleable and Shape-Changing Devices

Sean Follmer¹, Daniel Leithinger¹, Alex Olwal¹, Nadia Cheng², and Hiroshi Ishii¹

¹ MIT Media Lab
Cambridge, MA 02139 USA
{sean, daniell, olwal, ishii}@media.mit.edu

² MIT Mechanical Engineering
Cambridge, MA 02139 USA
ncheng@mit.edu

ABSTRACT

Malleable and organic user interfaces have the potential to enable radically new forms of interactions and expressiveness through flexible, free-form and computationally controlled shapes and displays. This work, specifically focuses on particle jamming as a simple, effective method for flexible, shape-changing user interfaces where programmatic control of material stiffness enables haptic feedback, deformation, tunable affordances and control gain. We introduce a compact, low-power pneumatic jamming system suitable for mobile devices, and a new hydraulic-based technique with fast, silent actuation and optical shape sensing. We enable jamming structures to sense input and function as interaction devices through two contributed methods for high-resolution shape sensing using: 1) index-matched particles and fluids, and 2) capacitive and electric field sensing. We explore the design space of malleable and organic user interfaces enabled by jamming through four motivational prototypes that highlight jamming’s potential in HCI, including applications for tabletops, tablets and for portable shape-changing mobile devices.

ACM Classification: H.5.2 Information Interfaces and Presentation: User interfaces and Evaluation; User Interfaces; Haptic I/O.

General terms: Design; Human Factors

Keywords: Jamming, Variable Stiffness, Organic User Interfaces, Malleable Input, Haptic Feedback.

INTRODUCTION

The form, function and dynamics of user interface devices have traditionally been limited by the rigidity of materials used for sensing and display. Organic User Interfaces (OUIs) [39] embrace the advances of new technology and materials to enable deformable and actuated interfaces of arbitrary shapes. Major enabling technologies for such interfaces have included advances in sensing [31], display tech-

Permission to make digital or hard copies of all or part of this work for personal or classroom use is granted without fee provided that copies are not made or distributed for profit or commercial advantage and that copies bear this notice and the full citation on the first page. To copy otherwise, or republish, to post on servers or to redistribute to lists, requires prior specific permission and/or a fee.

UIST '12, October 7-10, 2012, Cambridge, Massachusetts, USA.

Copyright 2012 ACM 978-1-4503-1580-7/12/10...\$10.00.



Figure 1: Jamming is a scalable technique for programmatic stiffness control, which can be applied to a variety of malleable and organic user interfaces. Examples include: Tunable stiffness for malleable interfaces on tabletops (a, c), for haptic feedback (b, c), and for mobile shape-changing interfaces (d).

nology and mechanical actuation [18, 30], but few projects investigate computationally controlled material properties, such as stiffness. In this paper, we adapt particle jamming [3, 22] as a simple, effective method of stiffness control in human—computer interaction (HCI). The ability to switch between soft and rigid material states enables novel interactions for malleable, clay-like interfaces, haptic feedback and deformable devices.

Granular media can exhibit both fluid-like and solid-like states. Liquids typically flow freely due to external forces, while solids require certain applied stresses to deform plastically. Jamming describes a situation when granular media exhibits a yield stress, such that forces can be distributed through chains of grains as if each chain was a rigid object [5]. Thus, groups of particles as a whole can function as a compliant or stiff material, under computational control of this compliance level.

Engineers, architects, and designers have been utilizing these

effective phase-change characteristics of granular media to develop devices, tools and systems that can transition between flexible and rigid states. Most applications induce jamming by enclosing grains in a non-porous, flexible membrane inside which a vacuum can be applied. The grains flow when excess interstitial fluid (typically air) is enclosed with the grains, but compact to form an effective solid when vacuum is applied inside the membrane to remove fluid. This enables drastic and reversible shape deformations using a single embedded actuator. Extremely flexible materials such as silicone can be utilized in jamming devices, allowing the system to be stretched, twisted, or bent with the jamming material flowing easily into these new shapes. However, when pressure is decreased these interfaces can become static. This makes jamming an ideal candidate for enabling malleable and shape changing user interfaces.

Jamming has become a popular research topic in the robotics community [3, 35, 36, 6], but its application to user interfaces has received less attention. A successful application of jamming to HCI requires advances in sensing to detect shape deformations and user input, as well as actuation for providing feedback to the user.

Contributions

We introduce techniques that exploit computer-controlled jamming of granular particles as a scalable method to programmatically control the stiffness of malleable devices. This, in combination with our embedded shape sensing, demonstrate the potential for novel interactions and increased expressiveness. Examples of how jamming can be utilized in HCI applications are illustrated in Figure 1 and 2. Our contributions include:

- A review of the state of the art in jamming for use as a variable stiffness material from an HCI perspective.
- A novel hydraulic-based jamming technology, for rapid activation, silent actuation, and embedded optical sensing.
- Two techniques for high-resolution, integrated and embedded sensing for jamming interfaces: optical sensing, using index-matched fluids and particles; and electrical sensing, using capacitive and electric field sensing.
- A small, low-power jamming system for mobile and embedded organic user interfaces.
- Motivating prototypes to highlight how jamming can be applied to HCI

RELATED WORK

Jamming in Mechanical Engineering

Recently, the potential of jamming to control material stiffness has been explored in various engineering fields. A universal gripper, composed of a balloon-like membrane filled with dry grains, will, for example, conform to an external object when the grains are in a loosely packed state. When air is removed to jam the grains into a rigid state, the object is perfectly grasped, as if the gripper was designed to take the form of the target object [3, 1]. The jammable gripper is actuated by a single vacuum pump, while most traditional grippers require one actuator (such as a motor) per joint, or degree of freedom. Jamming has also been explored in soft robotics, where robots transition between compliant and rigid, load-bearing states [35, 36, 6]; for medical devices that need to

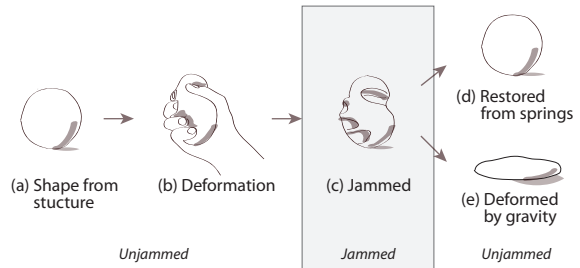

Figure 2: Jamming techniques enables new possibilities for shape state transitions. In this example, an object’s shape is informed from structure (a), deformed by a user (b), and jammed to maintain the deformation (c). When unjammed, the object could return to its original shape if there are internal spring forces (d) or deform due to gravity (e).

gently navigate in the body [23]; and for makeshift architectural structures constructed with jammable walls [16].

Malleable and Organic UIs

We position jamming interfaces in the space of malleable and organic UIs. In their unjammed states, jamming user interfaces with flexible skins allow deformation and manipulation, which makes them appropriate as malleable input devices. Particle-based materials, such as beads or sand (e.g., *Sandscape* [17]), as well as fluids (e.g., [13, 14]), have been previously explored for malleable interfaces. Passive springs can be used to provide haptic feedback for malleable input through the use of mechanical springs [28], gels [40, 8] or foam [34]. All of these interfaces have a static modulus of elasticity, which provides passive feedback to the user. In contrast, jamming interfaces can easily change their material stiffness to emulate interaction with different materials, or to increase the degree of control over the material. Coupled with the sensing techniques described in this paper, jamming enables a wide range of malleable interactions.

Organic UIs have explored bending and stretching as a means for input with flexible devices [32, 21, 12] and jamming can be used to control the degree to which these interfaces can be interacted with and the feeling of interacting with them.

Shape-changing UI

Shape-changing user interfaces can provide users with more affordances for different tasks, allow for greater tactile manipulability, or provide haptic feedback by changing their physical form [7]. Inflatable interfaces have been introduced that allow displays or objects to quickly change shape [20, 10], or to inform the user of program state [11]. Jamming can enable this type of interaction, by increasing the rigidity of a certain shape, while remaining easily actuated in another. In addition, unlike many shape-changing interfaces, jamming interfaces may be user defined and provide a wide design space of possible shapes.

Variable Stiffness for Haptic Feedback

Harnessing jamming for haptic feedback relies on its ability to control stiffness. Previous HCI research has explored variable stiffness materials, such as mechanical actuation for handheld squeezing [9], mouse-like interfaces [24], and rapid

localized feedback using Magnetorheological (MR) fluid for touch interfaces [41, 19].

While these techniques can be advantageous for rapid localized haptic feedback, the ability of jamming to vary the stiffness over much larger areas enables a wide variety of other applications and device scales. Jamming can also withstand a much higher loading stress than MR fluid.

Previous uses of jamming techniques in HCI

A wearable force display by Mitsuda et al., is a haptic feedback device for virtual reality applications [27]. It consists of flexible tubes, worn on the body, filled with Styrofoam particles, which can be jammed to constrain user motion. Position sensing is implemented with an embedded magnetic tracker at the end of the jamming tube; it does not measure the exact deformation of the device.

HoverMesh by Mazzone et al. applies a jamming technology with polystyrene beads to a tangible user interface [26]. It consists of a soft mesh that can morph into different shapes through computer controlled pneumatic cells. Jammable chambers in the skin of the interface solidify the shape when its deformation goal is reached. HoverMesh focuses on actuated shape output and does not implement user input through deformation sensing, although the authors discuss the possibility of employing computer vision methods or embedded bend sensors as a future work.

ClaytricSurface by Matoba et al. combines a malleable tabletop jamming surface with a ceiling-mounted depth-sensing camera and projector as a sculpting interface [25]. The malleable surface contains a pneumatic jamming apparatus, which allows for variable stiffness control.

We build upon previous jamming approaches with a systematic analysis of jamming’s potential for HCI, with a focus on deformable, organic and mobile user interfaces, and novel complementary sensing techniques.

BACKGROUND: PNEUMATIC JAMMING FUNDAMENTALS

This section provides an overview of how jamming activation techniques enable the control of shape and material stiffness, and thus the degree to which a volume can be physically modified or actuated. This section includes a review and introductory discussion of jamming control to provide readers with the background for implementing their own systems; further details can be found in [35]. We also describe a platform for prototyping jamming user interfaces.

Pneumatic Jamming

Four main elements are required to control a jamming system: the jammable material and housing assembly (usually a non-porous, flexible membrane), a vacuum source or pump, a pressure-controlling valve, and a pressure sensor. We have implemented a closed-loop control system to achieve desired vacuum pressures as a test platform. While pressure relates to the magnitude of jamming, there is not necessarily a linear relationship between pressure and system stiffness [36].

Our system consists of an Atmel AVR microcontroller that interfaces with a 12V DC vacuum pump with a 20 cm³/s maximum flow rate and a maximum vacuum pressure of 65

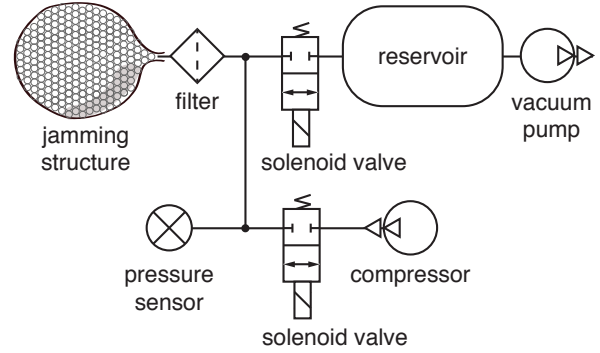

Figure 3: Pneumatic Jamming System. The system measures and controls the difference between atmospheric and internal volume pressure, such that particle jamming in the structure provides varying stiffness.

kPa, a 12V DC solenoid valve and an analog pressure sensor (see Figure 3). The vacuum pump, solenoid pressure-release valve and pressure sensor are connected in-line to the jammable module with 0.635-cm-diameter tubing. Coffee filters prevent particles from entering the air lines.

Differential jamming pressure and activation time

The differential jamming pressure is defined as the difference between atmospheric and internal volume pressure for the jammable module. For example, a balloon that is filled with jamming media and is open to atmospheric pressure, is near the jamming transition, since little fluid volume needs to be removed to induce jamming. The differential jamming pressure can, however, be raised to increase the mechanical stiffness of the system.

We can estimate the time it takes to cause a system to jam based on a pump’s rated flow rate. Uniform spheres that are of random, close packing (as opposed to, for example, ordered in a lattice pattern) have a solid volume fraction of approximately 0.64 [38]. Therefore, in a simple system in which a vacuum pump is directly connected to the jammable module, the amount of fluid volume, V_r , which needs to be removed to induce jamming can be approximated as:

$$V_r \approx V_b - V_g \left(1 + \frac{0.36}{0.64}\right) = V_b - \frac{m_g}{rho_g} \quad (1.5625)$$

where V_b is current internal volume of the jammable segment (including excess fluid), and V_g , m_g , and rho_g are the solid volume, the mass, and material density of the particles, respectively. Therefore, the time to remove the excess volume, t_r , is:

$$t_r = \frac{V_r}{Q_p}$$

where Q_p is the pump’s volumetric flow rate. Any additional vacuum that is applied to the system increases differential jamming pressure and system stiffness.

Accelerated Activation

While jamming speed is typically limited by the vacuum pump’s and pressure-control valve’s flow rates, it can be increased through the use of in-line reservoirs. For example, a

PVC pipe can be added to build up vacuum pressure to increase jamming speeds. In addition, unjamming speeds can be increased by adding a positive pressure source [1].

DESIGN CONSIDERATIONS FOR HCI

While actuated devices and displays have received extensive attention over the years, less emphasis has been placed on techniques for the control and modification of intrinsic material properties. The application of jamming has great potential to complement shortcomings of traditional shape-changing devices. In addition, due to its unique abilities to affect shape dynamics and kinetics, jamming is valuable as a standalone modality.

Facilitating shape deformation

Malleable interfaces typically need to both enable effortless deformation, while also providing mechanisms to stabilize resulting freeform shapes. Variable stiffness enables continuous transitions between compliant and solid objects. In addition to deformation in the unjammed state, and solidification of the resulting shape in the maximally jammed state, there are interesting nuances related to expression and fidelity in the range of stiffness levels in-between. The type of deformation that is possible, and its effect on the overall shape, depends on material stiffness. It is thus possible to tune the control gain to tweak the precision and scale of user manipulations of the material shape.

Augmenting shape actuation

Most actuation techniques for shape displays employ active elements to displace different types of media. While jamming does not provide actuation per se, it enables straightforward “locking” and “unlocking” of continuous freeform shapes with varying stiffness using a single actuator. The ability to maintain these states without the need to continuously power the jamming actuator is important for mobile, embedded and low-power devices. To change a jamming structure’s shape dramatically, another source of actuation is necessary: either a passive source, such as the user’s force or gravity, or an active source, such as a pneumatic air muscle. In addition to augmenting existing actuation techniques, novel actuators based on jamming structures could enable completely different shape-changing interfaces [35]. Granular particles can be combined with discrete element matrices as a hybrid approach to achieve smoother, higher-dimensional surfaces with variable stiffness. Passive, deformable shapes, with elastic or spring-loaded properties can also be added to the volume to provide restoring forces, so that when unjammed, the device returns to a certain shape.

The single actuator used to jam the particles may not only be used to accelerate the unjamming in reverse-operation, but could also be employed for inflation the jamming shape (similar to the technique described by Amend et al. [1]). By drastically changing the particle/medium ratio through inflation, we can allow the fluid jamming medium to dominate the shape volume and the user’s experience of it.

Haptic feedback through variable stiffness

The capability to control material stiffness can be used as a degree-of-freedom (DOF) for an output device. The device stiffness can be directly mapped to represent object proper-

ties in simulation interfaces, such as various materials in a sculpting application. Stiffness can also be mapped to represent parameters, states and action in the user interface, as classical abstract haptic feedback.

Sensing structure and touch

It is often desirable to sense users’ freeform deformations of malleable devices, including 3D shapes, as well as interaction on and above surfaces. Sensing proximity and touch allows 2D and 3D non-planar surface manipulations, which can be relevant and useful for a number of interactions [2]. Shape deformation can, besides the direct 1:1 manipulation of geometry representations, also be used in pattern-matching of shapes. This could, for example, allow the embodiment of functionality, such that the device’s behavior and interface would adapt to its form factor, or trigger different actions.

Jamming provides great flexibility for adapting the choice of particles and medium to a particular sensing approach, since there are no active electrical or mechanical elements that can cause interference in the volume.

Particle Types, Jamming Quality and Tactile Experience

The effect that different particle properties, such as size and shape, have on jamming performance has been extensively studied [23, 35, 6]. For user interfaces, the tactile experience is an additional important aspect.

For shape-changing interfaces, we are interested in particles that could achieve large changes in stiffness and jam in arbitrary freeform shapes. Ground coffee has previously been demonstrated as an effective material for systems that require large dynamic range in stiffness and strength [3, 6].

Glass beads provide a good balance of control and tactile stiffness response due to their smooth surfaces and low inter-particle friction. This allows for a precise control over levels of stiffness for malleable manipulations, such as sculpting.

Other properties, such as particle weight or membrane thickness and elasticity, can be optimized for a particular system design. The membrane qualities, for example, affect both the user’s tactile experience and the jamming performance.

NOVEL JAMMING TECHNIQUES

Mobile Jamming Platform: Pneumatics for Portability

Jamming has great potential in enabling haptic feedback, malleable input, and shape-changing structures for flexible mobile devices, such as future tablets, e-readers or cell phones. Mobile jamming needs to be compact and self-contained, which introduces constraints on size, flow rate, maximum vacuum force, power consumption and sound level (e.g., due to the vacuum pump).

Our Mobile Jamming Platform (MJP) consists of a small vacuum pump, small solenoid valve, control circuit and battery pack, and measures $47 \times 27 \times 8$ mm³ (see Figure 4). The pump draws 0.12A at 7.4V, and our current 100 mAh LiPo battery allows for one hour of continuous use of the pump, which means several hours in practice, as stiffness changes are rendered intermittently. Our MJP can currently

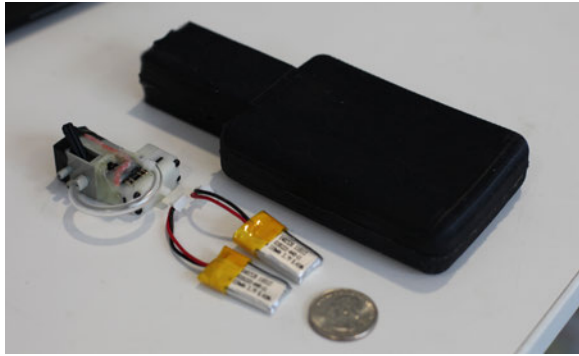

Figure 4: Our Mobile Jamming Platform (MJP) enables pneumatic jamming in a compact, low-power, battery-driven form factor. The MJP consists of a jamming volume, micro air pump, valve and LiPo batteries. (U.S. quarter for scale)

jam/unjam a cell-phone-sized volume of coffee particles in approximately one second.

Hydraulic Jamming: Fast, Silent and Transparent

Hydraulic jamming systems can be created by using liquids as the interstitial fluid between the particles, instead of air (a gas at room temperature). Since liquids are incompressible, hydraulic systems have higher efficiency, can be stiffer, quieter and can withstand more stress and load compared to pneumatic systems [15]. Hydraulic jamming can also enable optical sensing and transparency through the use of index-matched fluids and particles, which we describe in the next section.

We built several hydraulic jamming systems to investigate feasibility and performance compared to pneumatic systems. The system design is similar to a pneumatic system: a DC hydraulic pump, controlled by an H-bridge and microcontroller, moves liquid in and out of the system from a reservoir to change the differential jamming pressure. The pressure is digitally measured with a pressure sensor, and regulated by a control circuit and a hydraulic pump, as shown in Figure 5. Our hydraulic gear pump is $7.62 \times 10.16 \times 5.08 \text{ cm}^3$, with a 2.3 liter/minute maximum flow rate and a maximum pressure of 151 kPa. Metal mesh filters prevent particles from entering the fluid line and the pump. The pressures required for

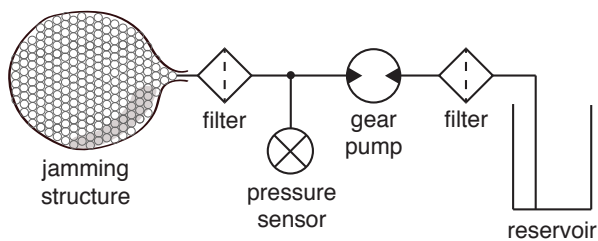

Figure 5: Hydraulic jamming system. Similarly to a pneumatic system, a closed-loop control system measures and manages the differential jamming pressure. Hydraulics can, however, allow higher stiffness, silent operation and faster actuation.

jamming are significantly lower than pressures used in traditional hydraulic actuation systems because we are not trying to transmit large forces; the goal is to change the interior pressure in reference to the external air pressure of 101.325 kPa.

SENSING FOR JAMMING INTERFACES

In this section, we discuss approaches that are particularly suitable to enable the shape and touch sensing that is necessary to leverage the flexibility and malleability of jamming structures for HCI.

Optical Sensing through Transparent Jamming Volumes

To enable optical sensing of the interface's 3D shape, while avoiding user interference, occlusion and bulky system configurations, it is necessary to integrate cameras below the surface. This, however, requires thin [4] or optically transparent material [8].

Index-matched Hydraulic Jamming A jamming system cannot provide optical transparency simply by using transparent particles, as each particle acts as a light-scattering lens, which makes the overall volume opaque. As light leaves the medium (e.g., air) and enters the particle (e.g., a glass bead), it refracts at an angle governed by Snell's law, due to the different refractive indices. However, by using a fluid that matches the refractive index (n) of the particle, we can suppress refraction and create an optically transparent volume.

Our hydraulic jamming system gives us flexibility to select fluids and particles with matching refractive indices. We chose to use the combination of borosilicate (Pyrex) glass beads ($n=1.474$) and vegetable oil ($n=1.4674-1.4736$, depending on temperature and density). The volume is not completely transparent due to a slight deviation in the refractive indices.

However, our experiments show that the system is sufficiently transparent for optical sensing using projected reference patterns up to an 8 cm thickness of particles. The opacity was measured using a 2 mW red laser and a photometer at different reference thicknesses, and compared to glass beads alone. We determined that 4 cm of glass beads and oil provides 94% transmission, and virtually no transmission for glass beads alone, whereas 8 cm of glass beads and oil provides 47% transmission (see Figure 6). This configuration allows a rear-mounted camera to see through our

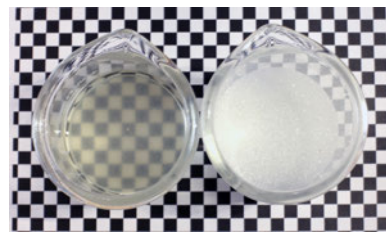

Figure 6: Transparency through index-matched fluid and particles. 3.5 cm of 1 mm Pyrex glass beads immersed in index-matched oil (left), and air (right). The oil reduces refraction as light enters and leaves each glass bead, with a drastic increase in transparency.

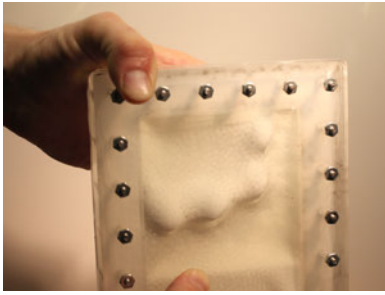

Figure 7: Jamming volume for optical sensing. 3 mm of Pyrex glass beads with index-matched fluid and particles enclosed between a flexible white membrane and a clear plastic sheet. Surface deformations are visible through 8 cm of jamming material.

transparent jammable volume, composed of index-matched fluid and glass beads with a transparent plastic bottom and an upper flexible opaque silicone skin, as shown in Figure 8. This device enables the use of different optical techniques for surface reconstruction, such as shape from shading, photometric stereo, embedded tracking markers in the skin [40], structured lighting, or other custom solutions [8].

Depth from Structured Light through Transparent Volume For 2.5D sensing through the optical jamming system we choose a custom IR structured light 2.5D scanning system, similar to the deForm system [8], due to its high resolution capture, ability to rear-project visible light content, and its flexibility with regards to changing cameras, projectors, and lenses. Three sequential fringe patterns are rear-projected in IR onto the deformable skin and are captured in 640×480 pixels at 60 frames/s by a side-mounted, synchronized IR camera. The 3 mm-thick silicone skin, with a durometer of 10 shore A, can be stretched and deformed 30 mm above and below its resting height. The deformations of the three patterns are used to reconstruct 2.5D images at 20 frames/s from a $23 \times 18 \text{ cm}^2$ region, at a spatial resolution of 28 pixels/cm, and 0–6 cm depth range, providing a 1–2 mm depth resolution.

Touch Sensing using Structured Light The greyscale surface image from our structured light capture system is also used to track touch points. The system works similarly to an IR diffuse illumination touch system, as the IR projector illuminates the silicone skin. By utilizing a thin, semi-transparent skin made of silicone, the camera captures reflections from fingers as they make contact. Other touch sensing techniques, such as FTIR, could also be explored with our transparent jamming system.

Limitations While this approach provides high-resolution shape and deformation tracking combined with touch sensing, its use is limited to hydraulic jamming systems. Camera and optical sensor placement restricts the system’s flexibility, and non-perfect index-matching complicates sensing at greater depths as transparency decreases.

Capacitive Shape Sensing

Capacitive sensing can provide a scalable embedded approach to sensing shape in jamming interfaces, including deforma-

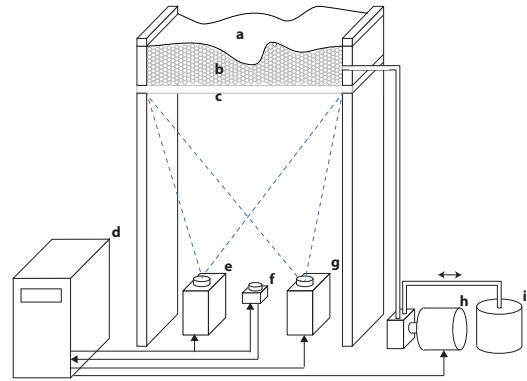

Figure 8: Structured Light Depth Sensing System with Index-Matched Jamming: (a) Silicone Membrane, (b) Pyrex glass beads and oil, (c) acrylic plate, (d) computer, (e) structured light IR projector, (f) IR camera, (g) graphics projector, (h) hydraulic pump, (i) reservoir

tions such as stretching, bending and twisting. In contrast to other techniques, such as resistive pressure sensors or electric impedance tomography, capacitive distance and shape sensing do not rely on a present applied force to the sensor. This makes it advantageous for both absolute and relative input.

Distance Sensing The amount of known dielectric material between two electrodes can be measured through capacitance, and correlated with the distance between them. Pressure sensors have employed this principle [33], which also extends to larger distances and electrodes that can be used for flexible jamming volumes. In our system, an electrode transmits a reference square wave in the 100 kHz range to a receiving electrode, and the signal is sampled by a 12-bit A/D converter in an ARM microcontroller running at 72 MHz. We use synchronous under-sampling to demodulate the signal and recover the original amplitude, which is proportional to the capacitance between the electrodes. 32 samples are averaged to remove white noise.

Dielectric Properties and Sensitivity Stretchable and bendable electrodes are needed for integration in the flexible jamming volume. We use silver-plated 76% nylon, 24% elastic fiber fabric, which has a low surface resistivity, and can be stretched up to twice its length. We insulate the fabric in a non-conductive silicone cast and use Pyrex glass beads as dielectric material. Pyrex glass beads have a dielectric constant of 4.6, whereas air has a dielectric constant of 1.00059. Assuming a random close-packing of glass spheres, 64% of the volume will be glass and 36% will be air [38], resulting in an overall average dielectric constant of 3.3. Hydraulic jamming greatly raises the possibility of increasing this dielectric constant. Using water with glass beads in the jamming volume could approach an average dielectric constant of 30 and increase sensing resolution at larger distances. With simple two-electrode capacitive sensing through glass beads we are able to measure distances of 0–20 cm, with 5 mm or better accuracy (accuracy increases when the two plates are closer to each other).

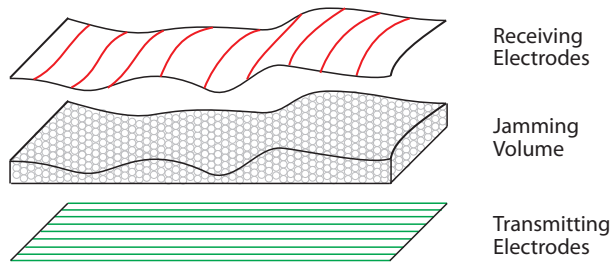

Figure 9: Capacitive shape sensing system. The jamming volume's shape is computed by measuring the capacitance at each transmitter-receiver electrode intersection.

Shape-sensing Prototype Using rows of transmitting electrodes in a rigid back, and columns of receiving electrodes in a flexible skin, we sense the jammable volume's shape through time-division-multiplexing for each of the intersections in the sensing matrix and output a 2.5D depth map. Our prototype of the capacitive shape-sensing input device with jamming haptic feedback uses a 9×9 electrode grid. It measures $25 \times 17.5 \times 3 \text{ cm}^3$ with an active sensing volume of $18 \times 11.5 \times 3 \text{ cm}^3$. An overall 25-mm thickness filled with 2 mm glass beads are sealed within a highly flexible upper membrane and a bendable, yet relatively rigid, bottom surface. This device can be placed on a desk, or embedded in the back of a mobile phone or a tablet. Conductive fabric strips ($9 \times 1 \text{ cm}^2$ each) are embedded in the flexible skin as receiving electrodes, while strips of copper tape (also $9 \times 1 \text{ cm}^2$ each) on the opposing, bottom surface act as transmitting electrodes, as shown in Figure 9. In addition, a layer of grounded conductive fabric on top of the flexible skin shields the system from the user. An analog multiplexer connects the receiver electrodes to our amplifier circuit and ADC. The current prototype runs at 30 Hz and transmits data over USB serial or wirelessly using Bluetooth. The depth map is filtered and scaled by a factor of ten through bi-cubic interpolation (see Figure 10). The speed and resolution could be increased with dedicated hardware, and code-division-multiplexing could be applied for scalability.

Sensing additional dimensions Separating transmitting and receiving electrodes into rows and columns for deformation sensing is only one approach to capacitive shape sensing

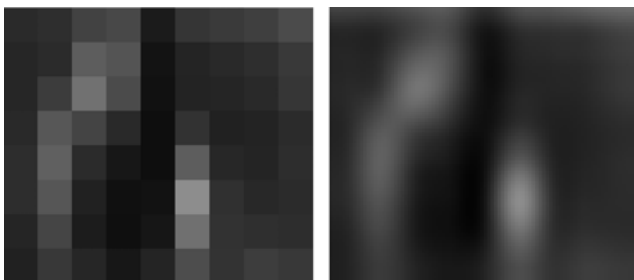

Figure 10: Left) Raw depth map output of 9×9 capacitive shape sensing system. Right) Bicubic interpolated depth map.

electrode layouts; additionally, each electrode can act as both a transmitter and receiver. This can enable stretch, tilt or twist input to be quantified by measuring capacitance between adjacent electrodes with different layouts.

Integrating Capacitive Touch Sensing Our capacitive sensing also supports integrated multi-touch input. By replacing the flexible ground layer with lines of conductive thread that transmit the same reference signal, we enable mutual capacitance touch sensing [31]. When fingers or hands approach the conductive thread transmitting the reference signal, they capacitively couple with the system and decrease the signal. Time-division-multiplexing makes it possible to use the receiving electrodes both for shape-sensing electrodes below, and touch-sensing electrodes above, which reduces the total number of required electrodes for shape and touch sensing. To improve results, we use thin conductive thread (sewn in a zig-zag pattern for flexibility), instead of the thicker conductive stretch-fabric. The thread is more sensitive to capacitive coupling from the user, as its smaller size results in weaker coupling between transmitting and receiving electrode pairs. When not sensing touch, the conductive thread electrodes can be connected to ground to help shield the device. We built a small test system with a 3×3 touch-sensing grid for touch, pressure and hover sensing.

APPLICATIONS AND PROTOTYPES

We built four prototypes that investigate the potential of variable material stiffness for different user interfaces.

Tunable Clay: Precision and Quality through Stiffness

Tunable Clay (shown in Figure 11) is a malleable input device for 3D modeling, where material stiffness can be tuned to comply with different sculpting modes. The interface is inspired by our research group's previous work in 3D modeling in projects such as Illuminating Clay, SandScape [17] and deForm [8]; we are interested in observing how different materials influence the creative process. Tunable Clay is a $30 \times 33 \text{ cm}^2$ malleable tabletop, designed to mimic the malleability of clay, which is a continuous material that users can easily deform. Optical sensing—achieved using structured light through the back of the transparent, hydraulic-



Figure 11: Tunable Clay uses material stiffness as an extra dimension for 3D modeling in its malleable interface.

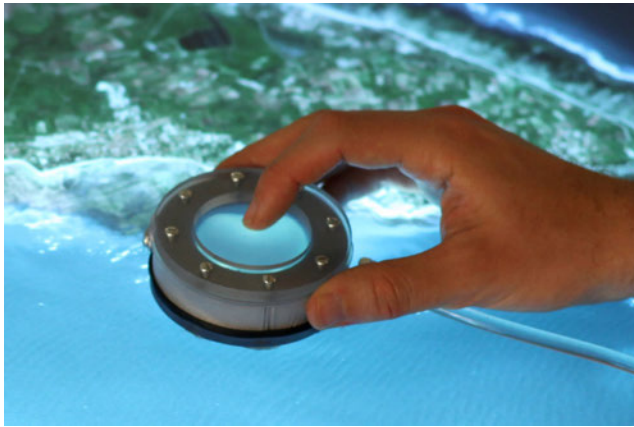

Figure 12: Users can press into the Transparent Haptic Lens to feel the stiffness of the underlying image region on the tabletop display.

activated jamming volume—captures the shape in real-time and applies it to a virtual 3D model. The model is shown both on a separate display and through projected graphics on the malleable surface for direct feedback. The sensing and visible projection is integrated beneath the surface to avoid occlusions from user interactions.

Users can control the stiffness of the malleable surface using a potentiometer. This allows users to modify the resolution of manual input, thereby modifying the interface’s control gain. One can increase the stiffness of the interface for detailed work, decrease it to increase malleability or to reset the shape. Tunable Clay highlights the potential benefits of controllable material properties to vary interaction style, precision and feel.

Transparent Haptic Lens: Content Representation

The Transparent Haptic Lens uses varying material stiffness as a haptic information channel. As shown in Figure 12, it consists of a round metal ring with a transparent base and a soft transparent upper skin (Smooth-On Dragon Skin 10) that is tracked on a tabletop display. Users can feel the apparent stiffness of parts of images by moving and pressing into the “lens”. An object’s haptic information channel is currently represented using 8-bit stiffness values in the alpha channel of the texture. By controlling the degree of jamming inside the lens, the stiffness perceived by the user can vary between a solid object and a liquid.

The jamming device is transparent and controlled hydraulically, as previously described. While haptic output through a tangible tabletop object has been previously explored (e.g., using servo motors [24]), the jamming mechanism inside the Transparent Haptic Lens can present continuous haptic sensations, such as liquids, which would be challenging to render using mechanical actuators. The transparency and shape of the lens also make it possible to provide users with optically magnified view of the objects they are touching.

Behind-the-Tablet Jamming: Haptic Program State

In order to investigate malleable interaction and haptic feedback in the context of mobile devices, we created a jamming



(a) Tablet Back (b) Tablet Front

Figure 13: The Behind-the-Tablet Jamming Interface enables malleable input with varying stiffness as haptic feedback, while avoiding occlusions with on-screen content.

input device mounted on the back surface of a tablet, shown in Figure 13. A custom tablet case has an embedded jamming apparatus and shape deformation sensor for malleable interaction in the back of the tablet. The tablet’s rear interface allows users to navigate content on a tablet display by pressing into its malleable surface. This could, for example, be used for browsing information on the tablet using gestures, while receiving jamming-driven haptic feedback. A possible scenario could use kneading on either side of the tablet back to scroll content in that direction, or using both hands to zoom. When a limit is reached, the corresponding part of the tablet could turn stiff, preventing further kneading. This scenario could also allow deformations beyond what is possible in the Tunable Clay interface, since there is no occlusion by the user’s hands. As in the previously described interfaces, changes in stiffness can enable different modes of user interaction.

The mobile jamming platform is pneumatically controlled with an on-board vacuum pump and uses capacitive shape sensing. We implemented two variations of the tablet. The first uses Bluetooth to communicate the capacitive shape sensing and jamming control to a tablet, which runs our Android application. The second used an iPad with screen-sharing software to view desktop applications that interface with the hardware over a serial cable.

ShapePhone: Shape-changing Devices

ShapePhone, depicted in Figure 14, is a user-defined mobile device that can be shaped into different forms and then locked into a rigid device for various forms of interaction. With our initial ShapePhone prototype users can transform the affordance of the device—from a phone, tablet (sheet), remote control, watch, game controller, or ball—by stretching, bending and molding ShapePhone when it is unjammed and thus extremely pliable, due to the stretchy silicone skin. The user can control the jamming state using a small switch. When unjammed, ShapePhone returns to its normal state of a phone-sized rectangle, using the silicone skin as a restoring force.

Our prototype uses the Mobile Jamming Platform, described earlier, to control jamming in a small form factor, and enables ShapePhone to be entirely self-contained. The phone-shaped hollow silicone (Smooth-On EcoFlex 0030) body was cast from a 3D-printed three-part mold. This particular silicone



Figure 14: The ShapePhone mobile device can be formed into different jammed shapes.

is very flexible and can stretch up to four times its size. The skin is filled with coffee grounds and sealed with a tube for airflow connected to the MJP.

It would be relatively straightforward to add the previously described capacitive shape sensing techniques to ShapePhone to sense a variety of different shapes. These shapes could be used in addition to contextual information gathered through other sensors, or program state, to enable further functionality. Capacitive touch sensing could also be incorporated for user input and recognize how the user is holding the device to enable contextual information [37].

This same jamming phone device could also be used for interaction and haptic feedback while in a pocket. Changes in stiffness could convey battery life, for example, letting the ShapePhone “melt” when it runs out of battery, or allowing user input through the pocket using squeezes or deformations.

DISCUSSION AND DESIGN CONSIDERATIONS

When designing a jamming system with shape and touch sensing, several design decisions are of importance, as demonstrated in our approaches for activation, sensing, and interactive applications and prototypes.

Jamming performance depends on activation technology and particle type, with hydraulic systems and high-friction particles offering wider dynamic stiffness range, while speed of activation can be accelerated using in-line reservoirs. Tactile experience, surface quality and malleability benefit from low-friction particles and thin, elastic membranes.

Hydraulic jamming enables optical shape and touch sensing through transparent volumes, and provides strong, rapid and silent operation. For mobile and embedded devices, pneumatic jamming has the advantages of being lightweight, sim-

ple and relatively small, as it can utilize the ambient air as the fluid reservoir. Our MJP demonstrates this with a combination of low-weight particles and compact elements for activation and capacitive sensing.

To address the loudness of most air compressors, such devices can be run at lower voltages if slower actuation speed is acceptable. The effect of gravity in a mobile jamming system can also be addressed using multiple compartments to constrain material placement.

FUTURE WORK

Our prototypes utilize passive actuation either from the user or from restoring forces. There is, however, a large space to explore in actuation. Techniques, such as pneumatic artificial muscles, as well as other inflatable structures, could be used to quickly change state and help jamming enable an even wider array of shape-changing interfaces. Our next steps are also to explore integration of our jamming techniques with actuated displays and devices.

Further work is required to explore other sensing techniques that can be integrated with flexible jamming devices. The conductive fabric we currently use is capable of only half the strain of that of the silicone used, and thus limits system flexibility. We plan to investigate other approaches to embedded electrodes and wiring, such as embedded liquid metal [29] and saltwater, for stretchable capacitive shape sensing.

Once flexible and stretchable displays are widely available, they will enable flexible mobile jamming devices with integrated displays. Until then, such future jamming devices and their related interactions can be prototyped using projection.

While we have focused on tangible, malleable organic user interfaces in this paper, jamming should also be explored in a wider context, as it is applicable to numerous applications such as haptic interfaces for VR, teleoperation, and ergonomic input devices.

CONCLUSIONS

This work demonstrates how jamming of granular particles can be applied to malleable, flexible and shape-changing user interfaces, and the interaction vocabulary made possible through programmable stiffness and control of material properties. By embedding sensing through index-matched optical sensing or capacitive shape sensing, we enable jamming interfaces to become high-resolution input devices. We also show how jamming can be miniaturized for mobile applications. Through four prototypes and two activation technologies, we demonstrate a range of possibilities of jamming user interfaces, and point towards future work. The wide variety of uses of jamming in our work highlights its applicability and potential for HCI in general, and to organic user interfaces, in particular.

ACKNOWLEDGMENTS

This work was supported in part by the National Science Foundation Graduate Research Fellowship under Grant No. 1122374. Alex Olwal was supported by a Swedish Research Council Fellowship and a Blanceflor Foundation Scholarship. We thank Brian Mayton, Rehmi Post, Steven Keating, and Ben Peters for their help with Electric Field Sensing

and our jamming prototypes. Thanks also to Dr. Karl Iagnemma and Prof. Anette Hosoi for their continued guidance in jamming-related work.

REFERENCES

- Amend, J., Brown, E., Rodenberg, N., Jaeger, H., and Lipson, H. A Positive Pressure Universal Gripper Based on the Jamming of Granular Material. *IEEE Transactions on Robotics* (2012), 341–350.
- Benko, H. Beyond flat surface computing: challenges of depth-aware and curved interfaces. In *ACM MM '09*, ACM Press (2009), 935–944.
- Brown, E., Rodenberg, N., Amend, J., Mozeika, A., Steltz, E., Zakin, M. R., Lipson, H., and Jaeger, H. M. Universal robotic gripper based on the jamming of granular material. *Proceedings of the National Academy of Sciences* 107, 44 (2010), 18809–18814.
- Cassinelli, A., and Ishikawa, M. Khronos projector. In *SIGGRAPH 2005 Emerging Technologies*, ACM Press (2005).
- Cates, M., Wittmer, J., Bouchaud, J.-P., and Claudin, P. Jamming, Force Chains, and Fragile Matter. *Physical Review Letters* 81, 9 (1998), 1841–1844.
- Cheng, N., Lobovsky, M., Keating, S., Setapen, A., Gero, K. I., Hosoi, A., and Iagnemma, K. Design and Analysis of a Robust, Low-Cost, Highly Articulated Manipulator Enabled by Jamming of Granular Media. *IEEE ICRA* (2012), 4328–4333.
- Coelho, M., and Zigelbaum, J. Shape-changing interfaces. *Personal and Ubiquitous Computing* 15, 2 (2010), 161–173.
- Follmer, S., Johnson, M., Adelson, E., and Ishii, H. deForm: an interactive malleable surface for capturing 2.5D arbitrary objects, tools and touch. In *UIST '11*, ACM Press (2011), 527–536.
- Gupta, S., Campbell, T., Hightower, J. R., and Patel, S. N. Squeeze-Block: using virtual springs in mobile devices for eyes-free interaction. In *UIST '10*, ACM Press (2010), 101–104.
- Harrison, C., and Hudson, S. E. Providing dynamically changeable physical buttons on a visual display. In *CHI '09*, ACM Press (2009), 299–308.
- Hemmert, F., Hamann, S., Löwe, M., Wohlauf, A., and Joost, G. Shape-changing mobiles: tapering in one-dimensional deformational displays in mobile phones. In *TEI '10*, ACM Press (2010), 249–252.
- Herkenrath, G., Karrer, T., and Borchers, J. Twend: twisting and bending as new interaction gesture in mobile devices. In *CHI EA '08*, ACM Press (2008), 3819–3824.
- Hilliges, O., Kim, D., and Izadi, S. Creating malleable interactive surfaces using liquid displacement sensing. In *Proc. Tabletop 2008*, IEEE Press (2008), 157–160.
- Hook, J., Taylor, S., Butler, A., Villar, N., and Izadi, S. A reconfigurable ferromagnetic input device. In *UIST '09*, ACM Press (2009), 51–54.
- Huber, J. E., Fleck, N. a., and Ashby, M. F. The selection of mechanical actuators based on performance indices. *Proceedings of the Royal Society A: Mathematical, Physical and Engineering Sciences* 453, 1965 (Oct. 1997), 2185–2205.
- Huijben, F., Herwijnen, F. V. A. N., and Nijssse, R. Vacuumatics 3D-Formwork Systems : Customized free-form solidification. *Nano*, figure 1 (2009), 1–4.
- Ishii, H., Ratti, C., Piper, B., Wang, Y., Biderman, A., and Ben-Joseph, E. Bringing Clay and Sand into Digital Design Continuous Tangible user Interfaces. *BT Technology Journal* 22, 4 (Oct. 2004), 287–299.
- Iwata, H., Yano, H., Nakaizumi, F., and Kawamura, R. Project FEELEX: adding haptic surface to graphics. In *SIGGRAPH '01*, ACM Press (Aug. 2001), 469–476.
- Jansen, Y., Karrer, T., and Borchers, J. MudPad: tactile feedback and haptic texture overlay for touch surfaces. In *ITS '10*, ACM Press (2010), 11–14.
- Kim, S., Kim, H., Lee, B., Nam, T.-J., and Lee, W. Inflatable mouse: volume-adjustable mouse with air-pressure-sensitive input and haptic feedback. In *CHI '08*, ACM Press (2008), 211–224.
- Lahey, B., Girouard, A., Bursleson, W., and Vertegaal, R. PaperPhone: understanding the use of bend gestures in mobile devices with flexible electronic paper displays. In *CHI '11*, ACM Press (2011), 1303–1312.
- Liu, A. Jamming is not just cool any more. *Nature* 396, November (1998), 21–22.
- Loeve, A. J., Ven, O. S., Vogel, J. G., Breedveld, P., and Dankelman, J. Vacuum packed particles as flexible endoscope guides with controllable rigidity. *Granular Matter* 12, 6 (June 2010), 543–554.
- Marquardt, N., Nacenta, M. A., Young, J. E., Carpendale, S., Greenberg, S., and Sharlin, E. The Haptic Tabletop Puck: tactile feedback for interactive tabletops. In *ITS '09*, ACM Press (2009), 85–92.
- Matoba, Y., Sato, T., Takahashi, N., and Koike, H. Claytricsurface: an interactive surface with dynamic softness control capability. In *SIGGRAPH '12 Emerging Technologies*, ACM (2012), 6:1–6:1.
- Mazzone, A., Spagno, C., and Kunz, A. The HoverMesh: a deformable structure based on vacuum cells: new advances in the research of tangible user interfaces. In *ACE '04*, ACM Press (2004), 187–193.
- Mitsuda, T., Kuge, S., Wakabayashi, M., and Kawamura, S. Wearable haptic display by the use of a Particle Mechanical Constraint. *Proceedings 10th Symposium on Haptic Interfaces for Virtual Environment and Teleoperator Systems. HAPTICS 2002* (2002), 153–158.
- Overholt, D. The MATRIX: a novel controller for musical expression. In *NIME '01*, AMC (2001), 1–4.
- Park, Y.-L., Majidi, C., Kramer, R., Bérard, P., and Wood, R. J. Hyperelastic pressure sensing with a liquid-embedded elastomer. *Journal of Micromechanics and Microengineering* 20, 12 (Dec. 2010), 125029.
- Parkes, A., Poupyrev, I., and Ishii, H. Designing kinetic interactions for organic user interfaces. *Communications of the ACM* 51, 6 (June 2008), 58–65.
- Rekimoto, J. SmartSkin: an infrastructure for freehand manipulation on interactive surfaces. In *CHI '02*, ACM Press (2002), 113–120.
- Schwesig, C., Poupyrev, I., and Mori, E. Gummi: a bendable computer. In *CHI '04*, ACM Press (New York, New York, USA, 2004), 263–270.
- Sergio, M., Manaresi, N., and Tartagni, M. A Textile Based Capacitive Pressure Sensor. *Sensors*, 2002. (2002), 1625–1630.
- Smith, R. T., Thomas, B. H., and Piekarski, W. Digital foam interaction techniques for 3D modeling. In *Virtual Reality Software and Technology* (2008), 61–68.
- Steltz, E., Mozeika, A., and Rembisz, J. Jamming as an enabling technology for soft robotics. *Electroactive Polymer Actuators and Devices (EAPAD)* (2010), 764225.
- Steltz, E., Mozeika, A., Rodenberg, N., Brown, E., and Jaeger, H. JSEL: Jamming Skin Enabled Locomotion. *2009 IEEE/RSJ International Conference on Intelligent Robots and Systems* (Oct. 2009), 5672–5677.
- Taylor, B. T., and Bove, V. M. Graspables: grasp-recognition as a user interface. In *CHI '09*, ACM Press (2009), 917–926.
- Torquato, S., Truskett, T., and Debenedetti, P. Is random close packing of spheres well defined? *Physical review letters* 84, 10 (Mar. 2000), 2064–7.
- Vertegaal, R., and Poupyrev, I. Organic User Interfaces. *Communications of the ACM* 51, 6 (2008), 26–30.
- Vlack, K., Mizota, T., Kawakami, N., Kamiyama, K., Kajimoto, H., and Tachi, S. Gelforce: a vision-based traction field computer interface. In *Ext. Abstracts CHI '05*, ACM Press (2005), 1154–1155.
- White, Tom. *Introducing Liquid Haptics in High Bandwidth Human Computer Interfaces*. PhD thesis, MIT, 1998.